

Instruction: LOD-C n

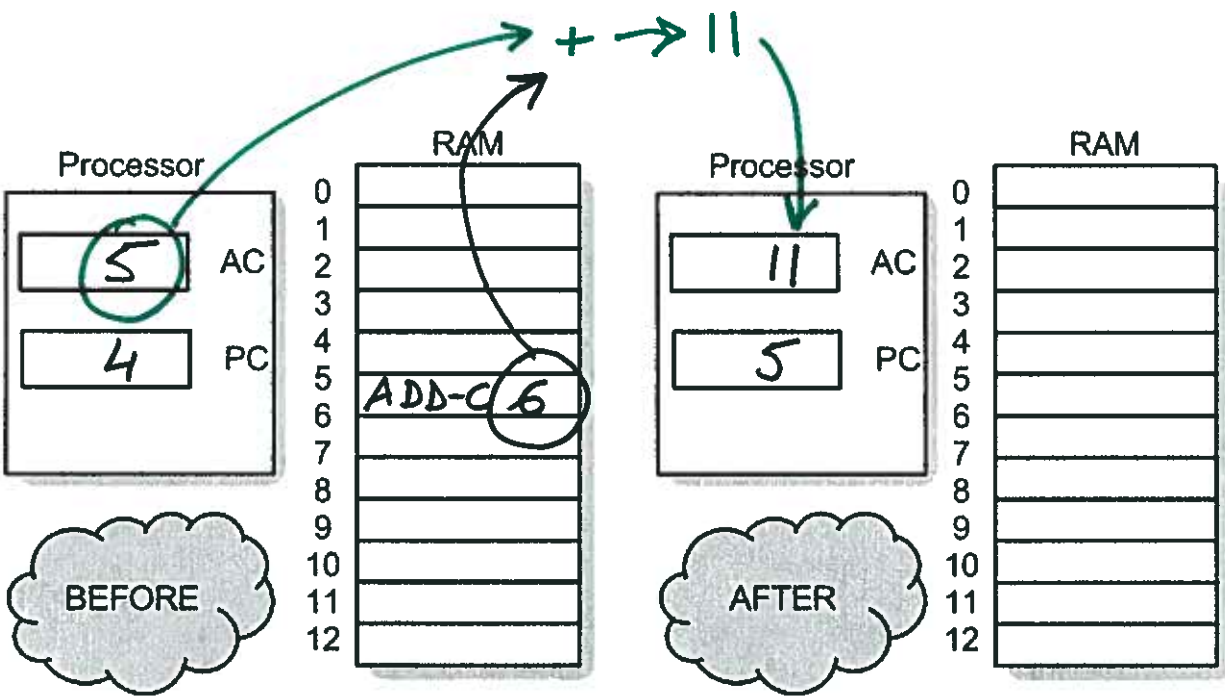

Instruction: ADD-C n

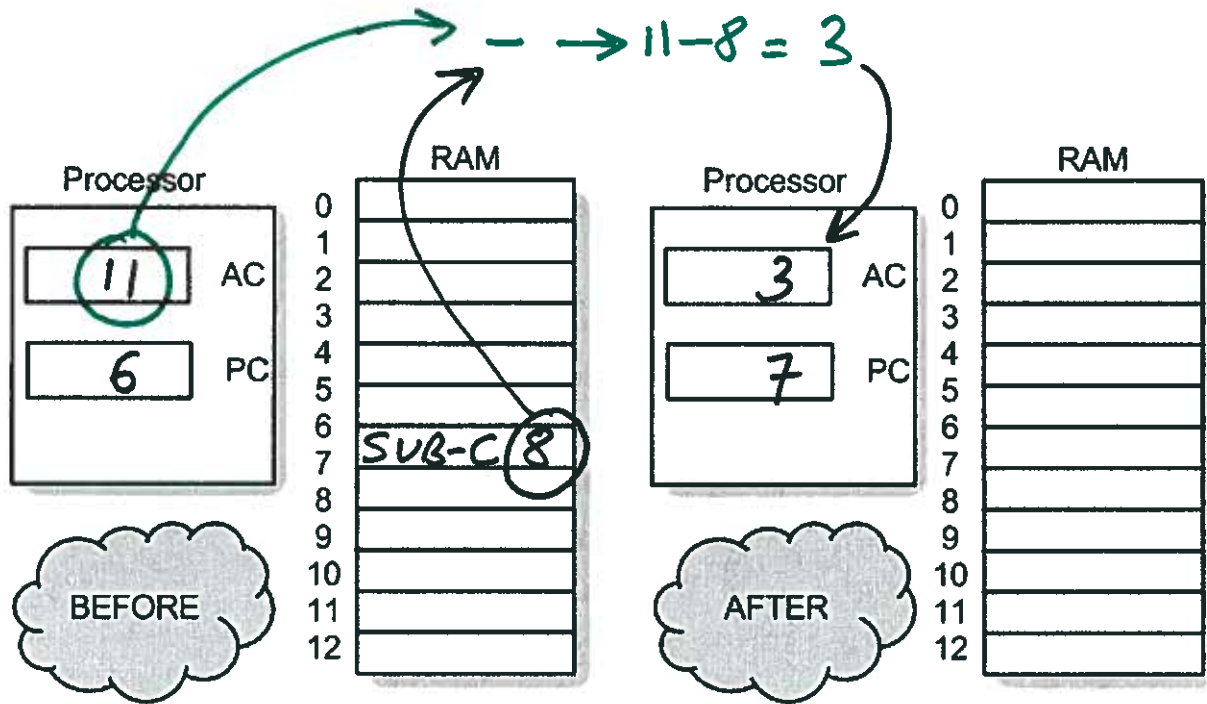

Instruction: SUB-C 8

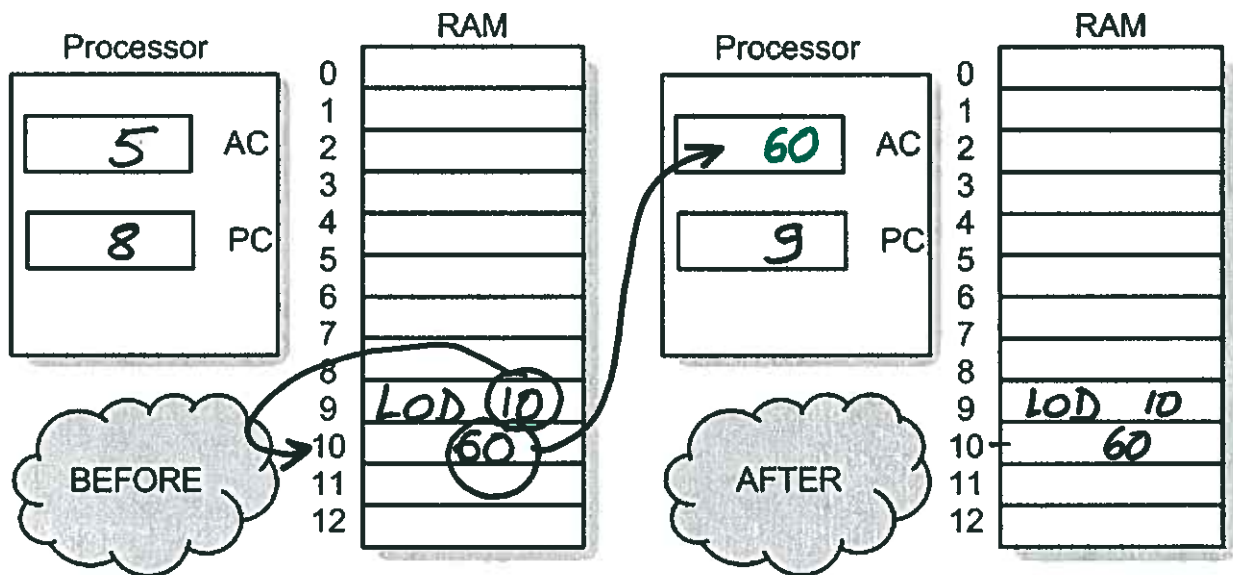

Instruction: LOD addr.

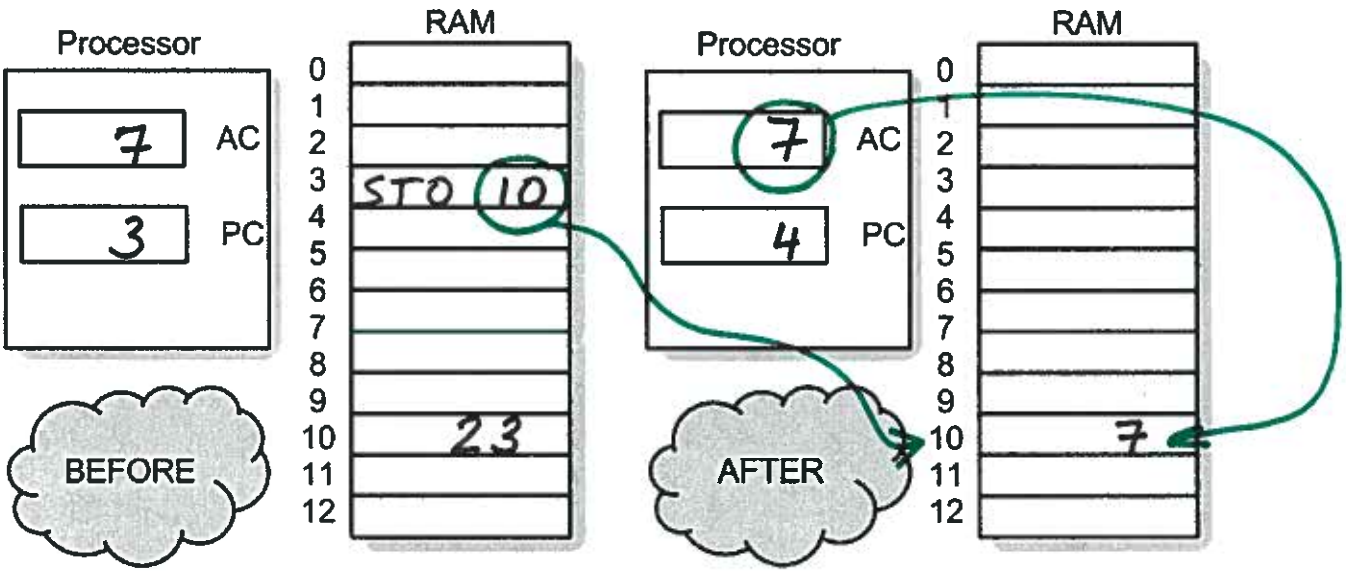

Instruction: STO addr

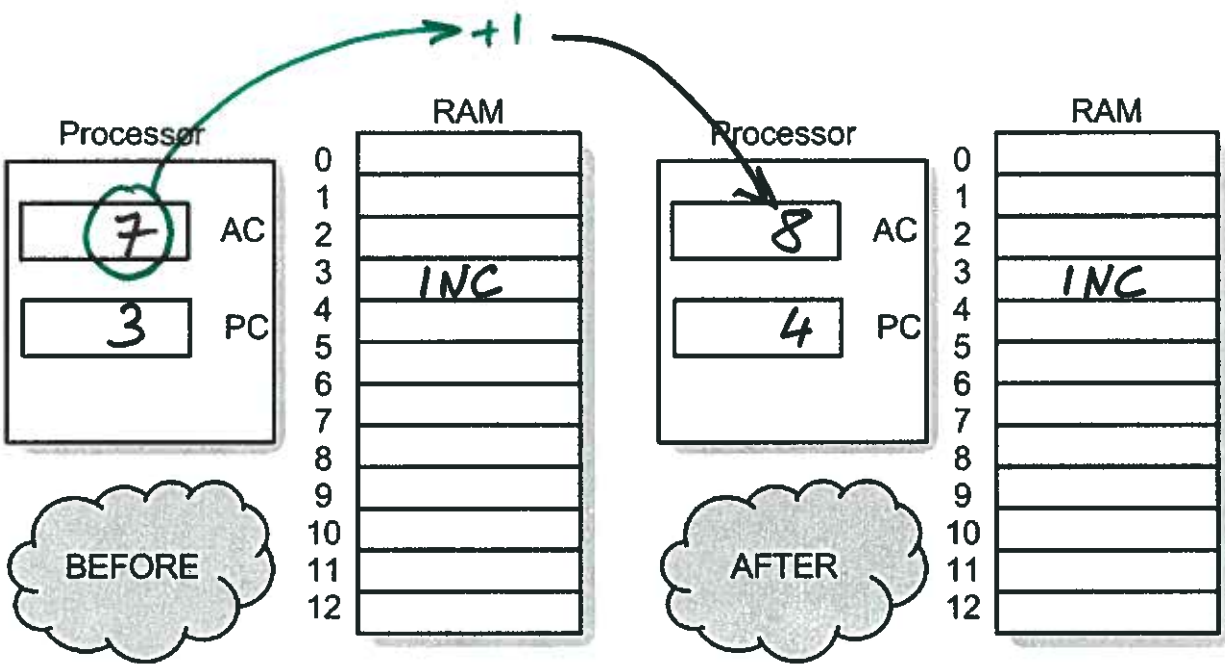

Instruction: INC

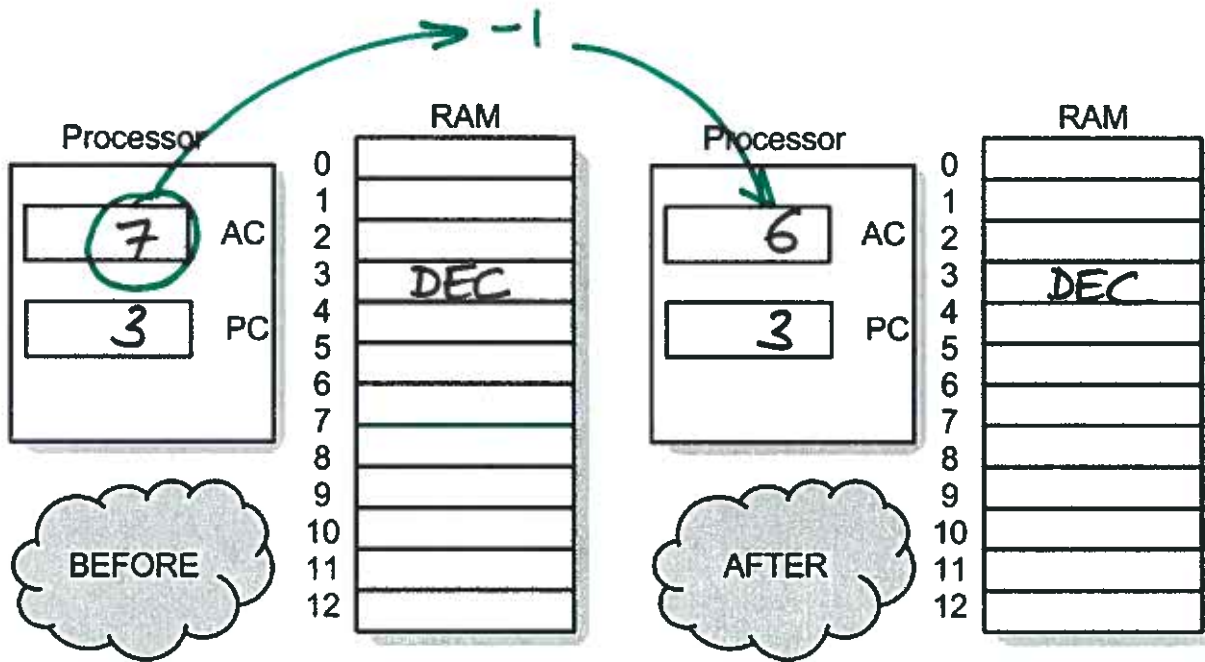

Instruction: DEC

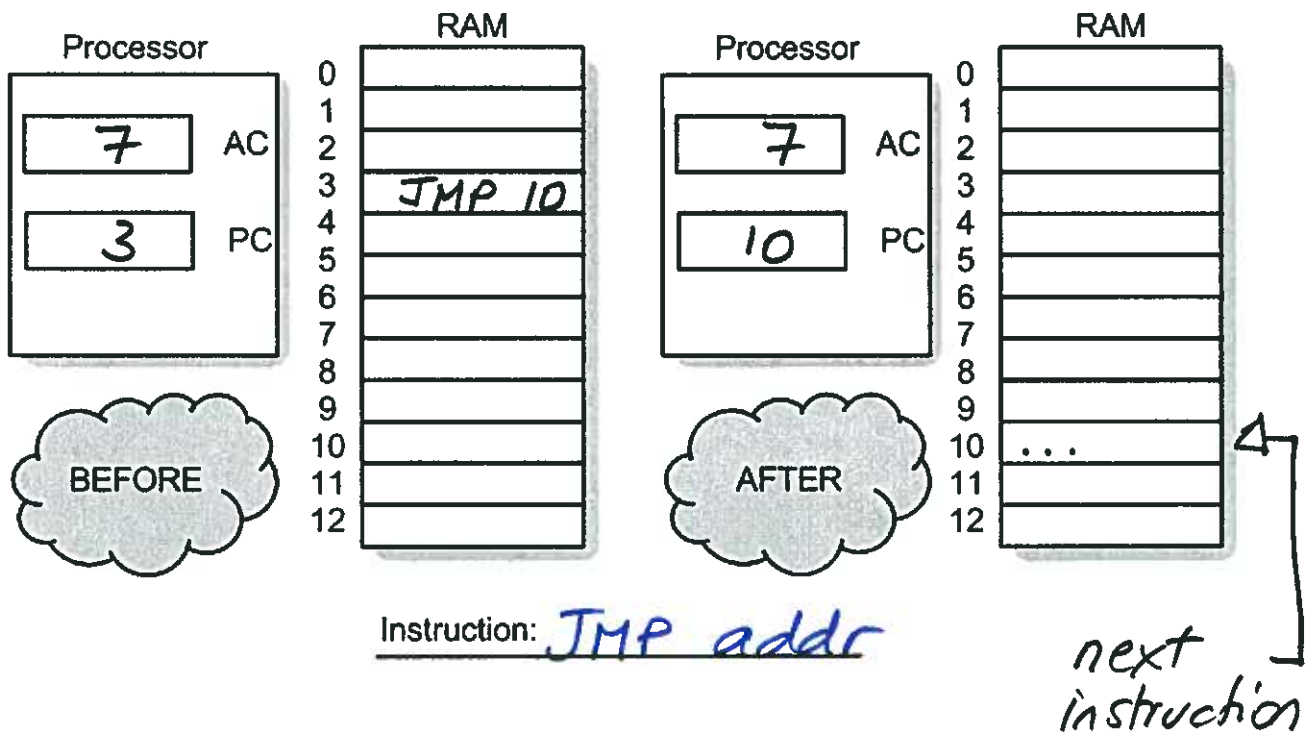

Instruction: JMP addr

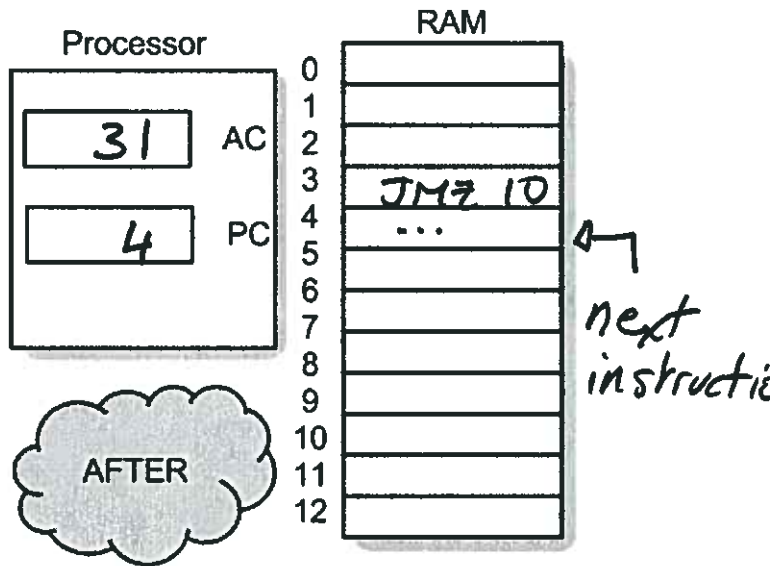
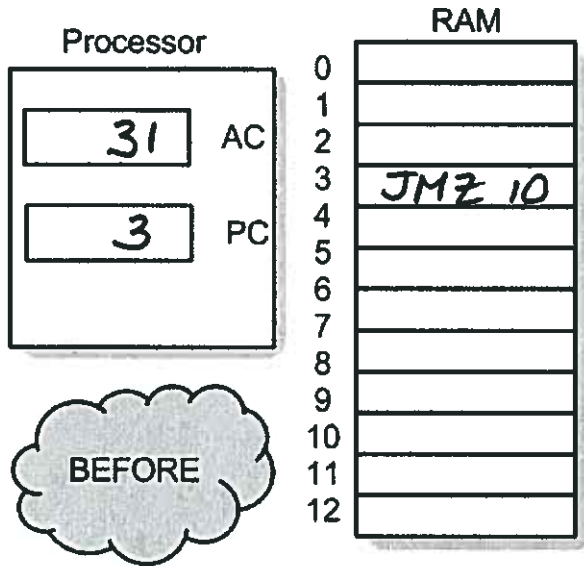

Instruction: JMZ addr

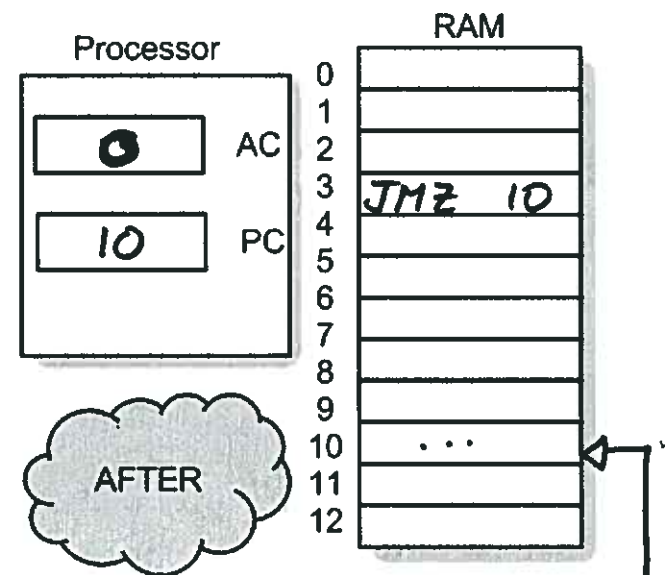
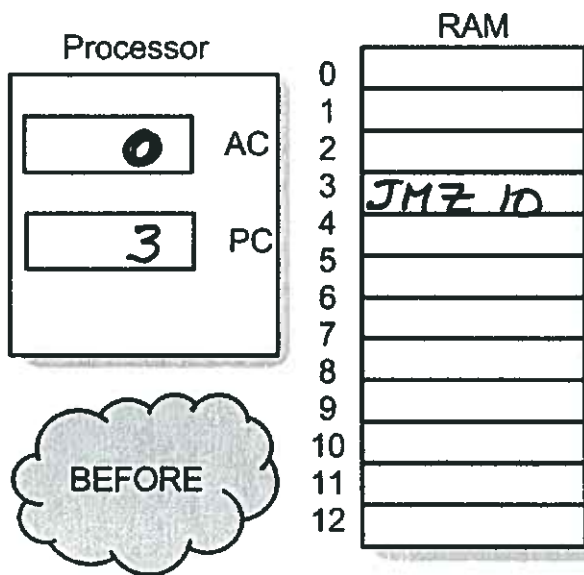

Instruction: JMZ addr